

213

STEREO POWER AMPLIFIER MX-1000/U

SERVICE MANUAL

MX-1000/U

IMPORTANT NOTICE

This manual has been provided for the use of authorized Yamaha Retailers and their service personnel. It has been assumed that basic service procedures inherent to the industry, and more specifically Yamaha Products, are already known and understood by the users, and have therefore not been restated.

WARNING: Failure to follow appropriate service and safety procedures when servicing this product may result in personal injury, destruction of expensive components and failure of the product to perform as specified. For these reasons, we advise all Yamaha product owners that all service required should be performed by an authorized Yamaha Retailer or the appointed service representative.

IMPORTANT: The presentation or sale of this manual to any individual or firm does not constitute authorization, certification or recognition of any applicable technical capabilities, or establish a principle-agent relationship of any form.

The data provided is believed to be accurate and applicable to the unit(s) indicated on the cover. The research, engineering, and service departments of Yamaha are continually striving to improve Yamaha products. Modifications are, therefore, inevitable and specifications are subject to change without notice or obligation to retrofit. Should any discrepancy appear to exist, please contact the distributor's Service Division.

WARNING: Static discharges can destroy expensive components. Discharge any static electricity your body may have accumulated by grounding yourself to the ground buss in the unit (heavy gauge black wires connect to this buss).

IMPORTANT: Turn the unit OFF during disassembly and parts replacement. Recheck all work before you apply power to the unit.

■ CONTENTS

TO SERVICE PERSONNEL	1	DISASSEMBLY PROCEDURES	5
SPECIFICATIONS	1	ADJUSTMENTS	5
FRONT PANELS	2	PRINTED CIRCUIT BOARD	6 ~ 13
REAR PANELS	3	SCHEMATIC DIAGRAM	14
BLOCK DIAGRAM	4	WIRING	15
INTERNAL VIEW	4	PARTS LIST	16 ~ 24

TO SERVICE PERSONNEL

- Critical Components Information.**
Components having special characteristics are marked Δ and must be replaced with parts having specifications equal to those originally installed.
- Leakage Current Measurement (For 120V Model Only).**
When service has been completed, it is imperative that you verify that all exposed conductive surfaces are properly insulated from supply circuits.
 - Meter impedance should be equivalent to 1500 ohm shunted by 0.15 μ F.
 - Leakage current must not exceed 0.5mA.
 - Be sure to test for leakage with the AC plug in both polarities.

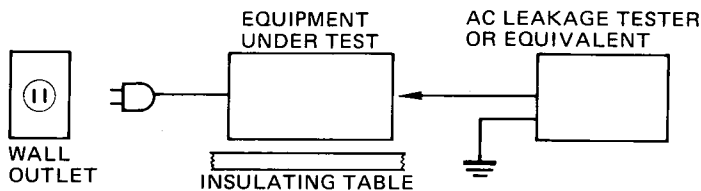

POLARIZATION (U, C models only)

This amplifier product is equipped with a polarized alternating current line plug (a plug having one blade wider than the other). This plug will fit into the power outlet only one way. This is a safety feature.

SPECIFICATIONS

Minimum RMS Output Power per Channel	
20Hz ~ 20kHz	
0.003% THD, 8 Ω	260W
0.007% THD, 6 Ω	295W
0.02% THD, 4 Ω	330W
Dynamic Power per Channel (by IHF Dynamic Headroom measuring method)	
8 Ω	450W
6 Ω	560W
4 Ω	740W
2 Ω	960W
1 Ω	1000W
DIN Standard Output Power per Channel	
1kHz, 1% THD, 4 Ω	450W (G)
Dynamic Headroom	
8 Ω	2.38dB (U, C, R)
6 Ω	2.78dB (U, C, R)
4 Ω	3.51dB (U, C, R)
IEC Power (1kHz, 0.01% THD)	
8 Ω	315W (G)
6 Ω	375W (G)
4 Ω	440W (G)
Power Band Width	
0.03% THD, 130W, 8 Ω	10kHz ~ 60kHz
Damping Factor	
8 Ω , 1kHz	130
Input Sensitivity/Impedance	
MAIN IN	1.62V/60k Ω
Frequency Response (20Hz ~ 20kHz)	
MAIN IN	+0, -0.2dB
Total Harmonic Distortion	
20Hz ~ 20kHz	
MAIN IN TO SP OUT (130W/8 Ω)	0.003%
Intermodulation Distortion	
Rated Output /8 Ω	0.003%
Signal to Noise Ratio (IHF-A Network)	
MAIN IN (Shorted)	126dB
MAIN IN (5.1k Ω terminated)	122dB
Residual Noise (IHF-A Network)	
	21 μ V
Channel Separation (Vol. -30dB)	
Input Shorted (1kHz/10kHz)	89dB/72dB
Power Supply	
	AC220/240V, 50Hz (B, G)
	AC110/120/220/240V, 50/60Hz (R)
	AC240V, 50Hz (A)
	AC120V, 60Hz (U, C)

Power Consumption	1100W, 1300VA (U, C) 850W (R) 1700W (A, B, G)
AC Outlet	Un Switched x 1
	200W max. (U, C, R)
Dimensions (W x H x D)	435 x 170 x 425mm (17-1/8" x 6-11/16" x 16-3/4")
Weight	20.5kg (45 lbs 4 oz)

* Specifications are subject to change without notice.

- (U) U.S.A. Model
- (C) Canadian Model
- (A) Australian Model
- (B) British Model
- (G) European Model
- (R) General Model

DIMENSION

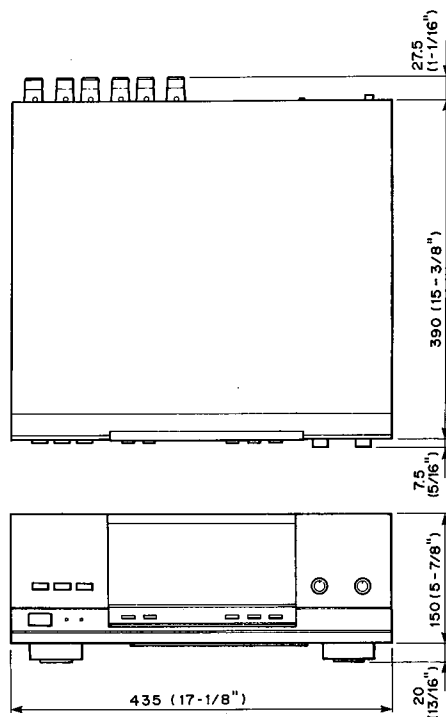

Unit: mm (inch)

MX-1000/U

FRONT PANELS

● MX-1000 (General, European, British & Australian models)

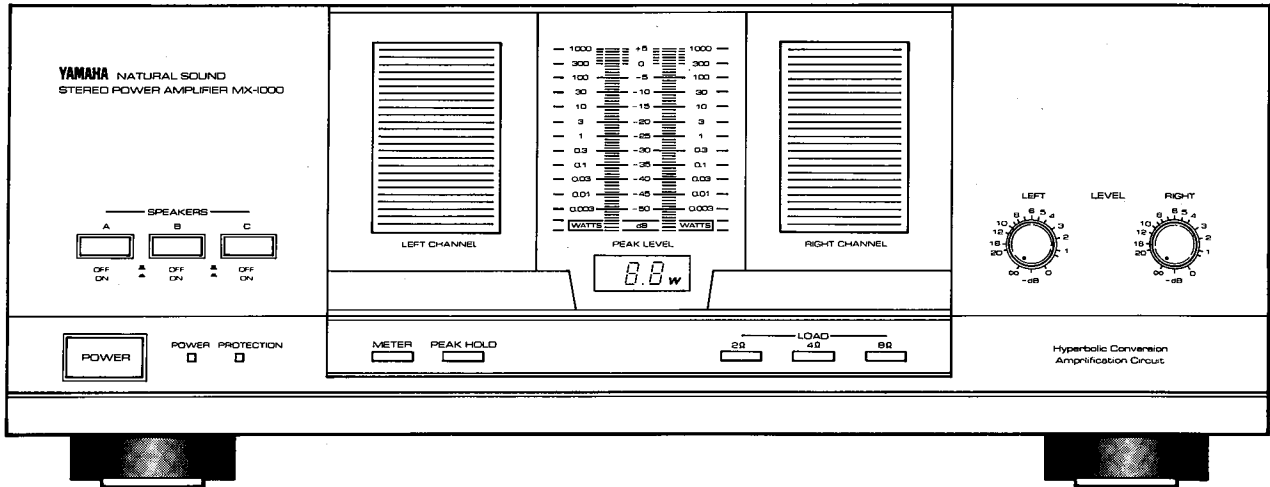

● MX-1000U (U.S.A. & Canadian models)

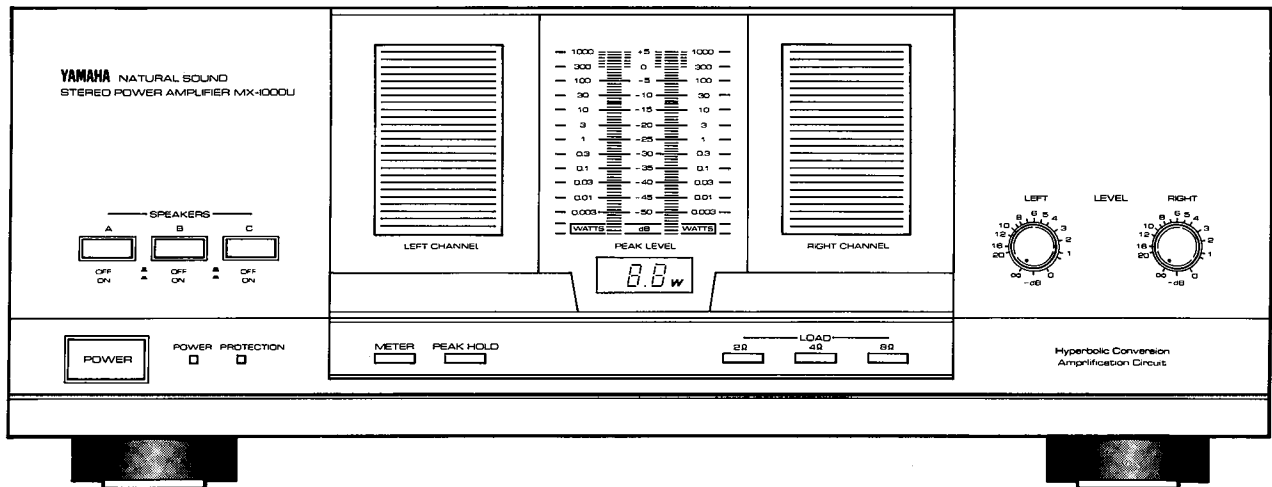

MX-1000/U

REAR PANELS

General model

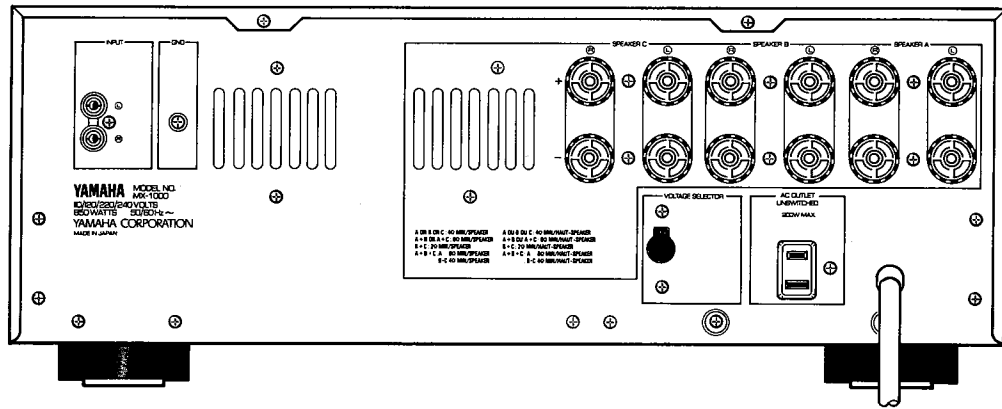

Australian model

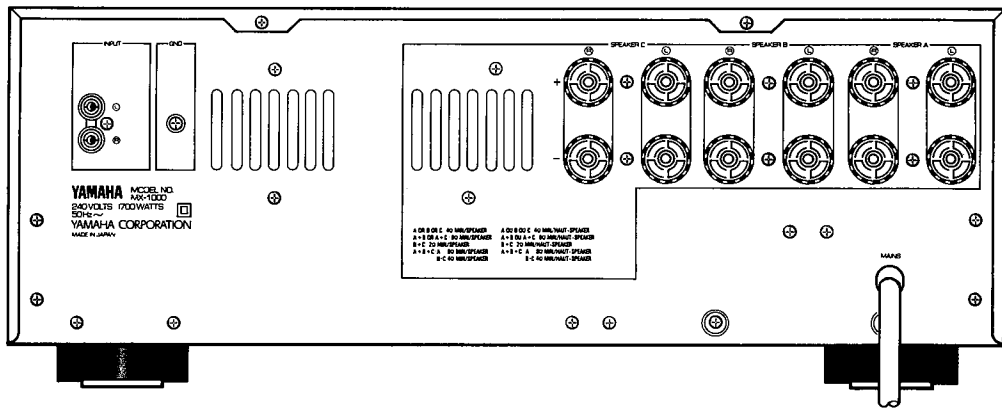

U.S.A. & Canadian models

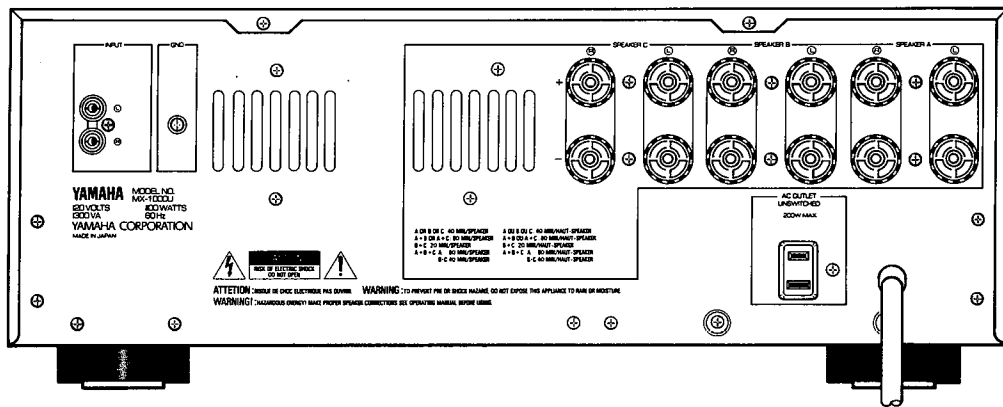

British & European models

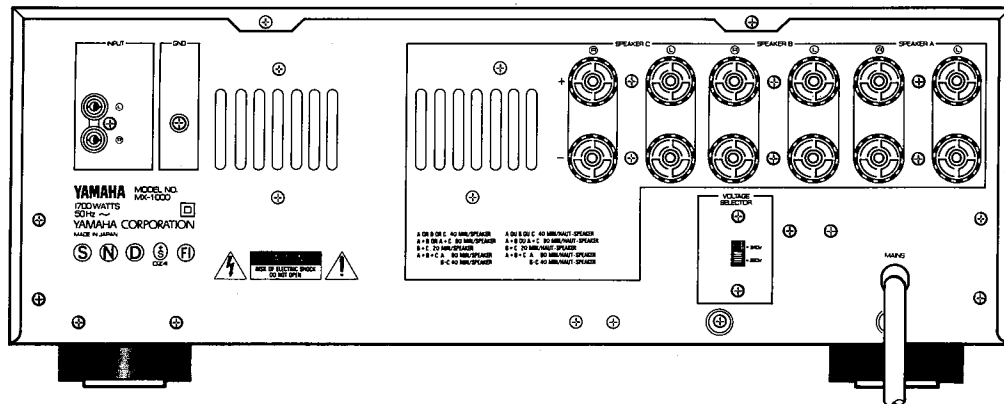

MX-1000/U

BLOCK DIAGRAM

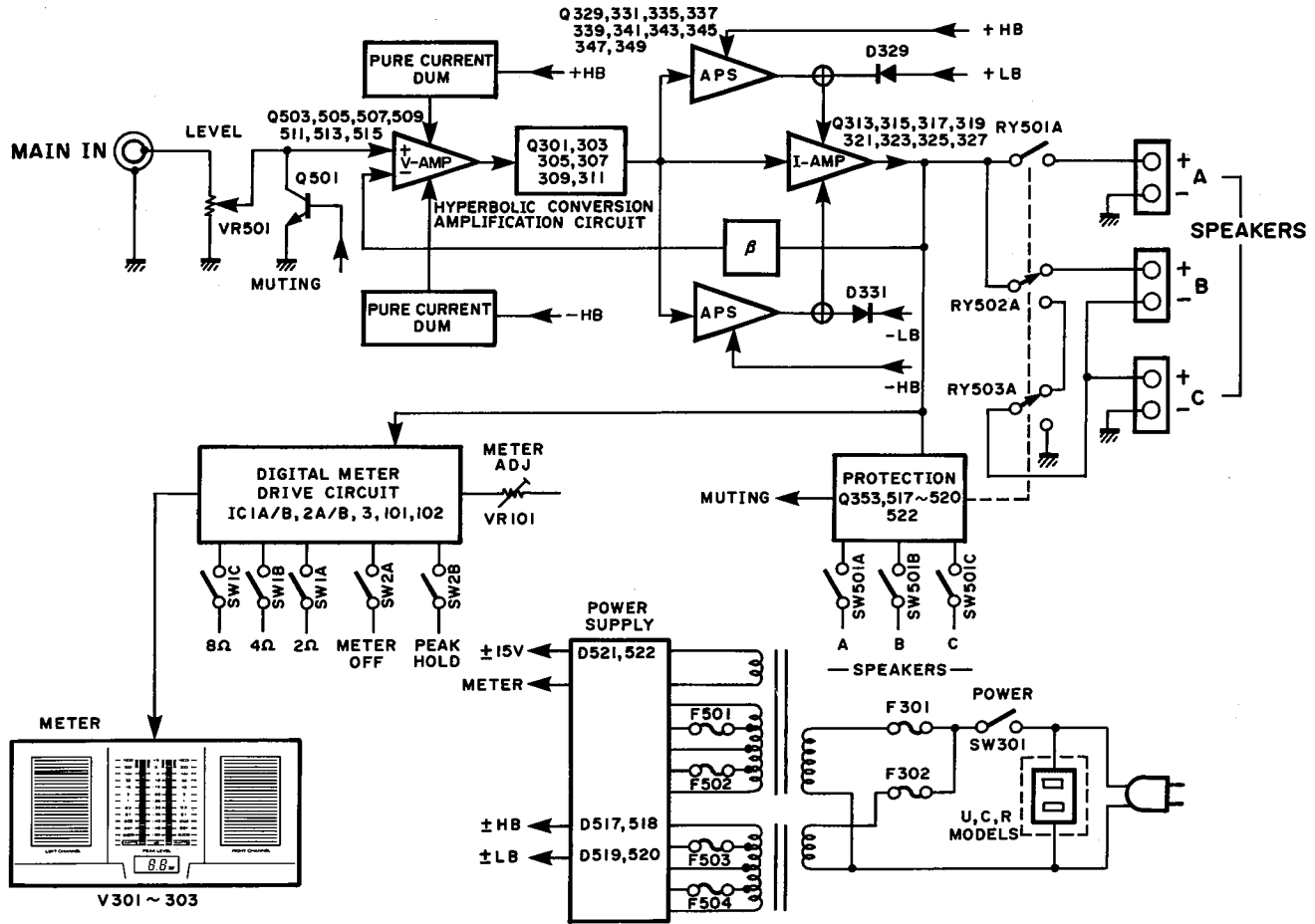

INTERNAL VIEW

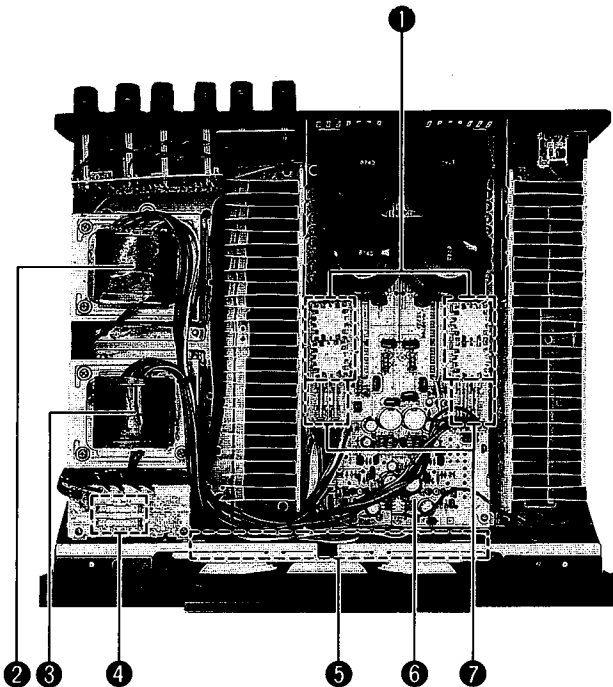

① DIODE BRIDGE : D5FB20
POWER TRANSFORMER

- U model : XE197001
- C model : XE199001
- R model : XE201001
- B, G models: XE203001
- A model : XE686001

③ POWER TRANSFORMER

- U model : XE196001
- C model : XE198001
- R model : XE200001
- B, G models: XE202001
- A model : XE685001

④ FUSE

- U, C models: 10A, 250V x 2
- A, B, G models: T4A, 250V x 2
- R models: 20A, 250V x 1

⑤ METER UNIT

⑥ MAIN CIRCUIT BOARD (1)

⑦ FUSE

- U, C, R models: 7A, 125V x 4
- A, B, G models: T6.3A, 250V x 4

MX-1000/U

DISASSEMBLY PROCEDURES

1. Removal of Top Cover.

Remove 6 screws (①) in Fig. 1. and slide the Top Cover back.

2. Removal of Bottom Cover.

Remove 6 screws (②) in Fig. 1.

3. Removal of Front Panel.

Remove 5 screws (③) in Fig. 1.

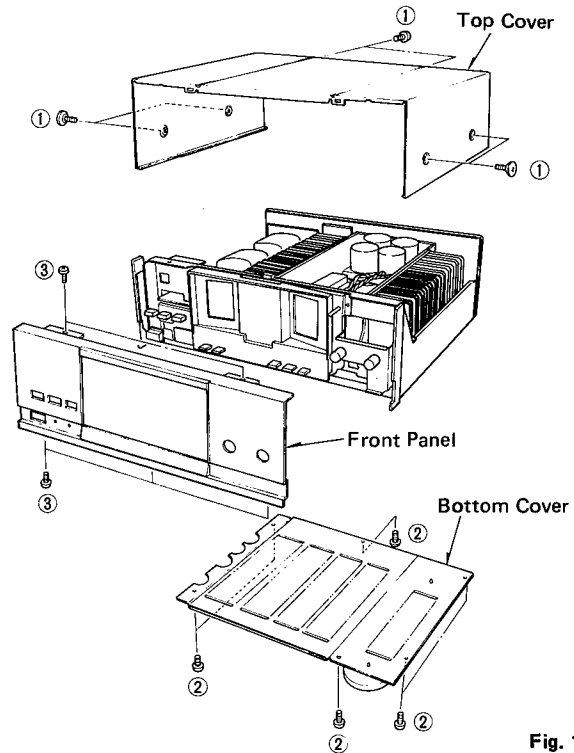

Fig. 1.

ADJUSTMENTS

• IDLING CURRENT ADJUSTMENT

Wait 2 minutes after power ON to stabilize amplifier operation without signal.

Adjust VR301 (Lch) and VR302 (Rch) so that the voltage across the terminals of R579 (Lch) and R578 (Rch) come to $10\text{mV} \pm 1\text{mV DC}$.

	Test Points	Adjustment Points	Rating
L ch	Across the terminals of R579	VR301	$10\text{mV} \pm 1\text{mV DC}$.
R ch	Across the terminals of R578	VR302	

• TEST POINTS

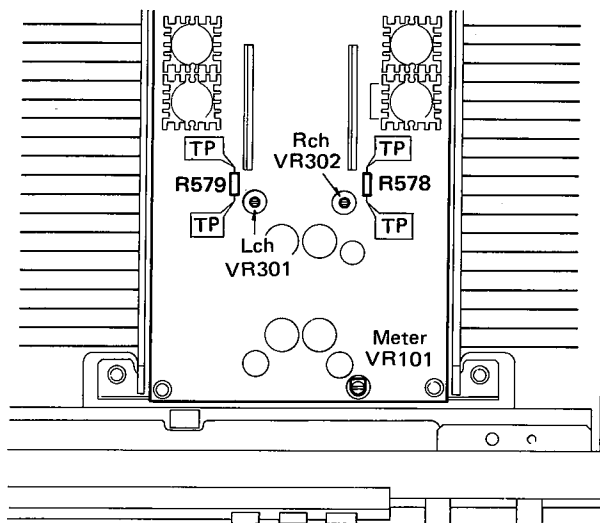

• METER LEVEL ADJUSTMENT

1) Set the controls to the following positions.

LOAD selector : 8Ω

Amplifier load : No load or 8Ω

PEAK HOLD switch : OFF

2) Apply a 1kHz sine wave signal from LINE IN so that SP. output voltage is 28.3V AC.

3) Adjust VR101 so that 99.3W of the digital meter display.

4) LOAD selector : 4Ω

Confirm that 199.W of the digital meter display.

5) Confirm that all segments fades out at no signal condition.

1 ■ PRINTED CIRCUIT BOARD (Pattern side)

Main Circuit Board (1)

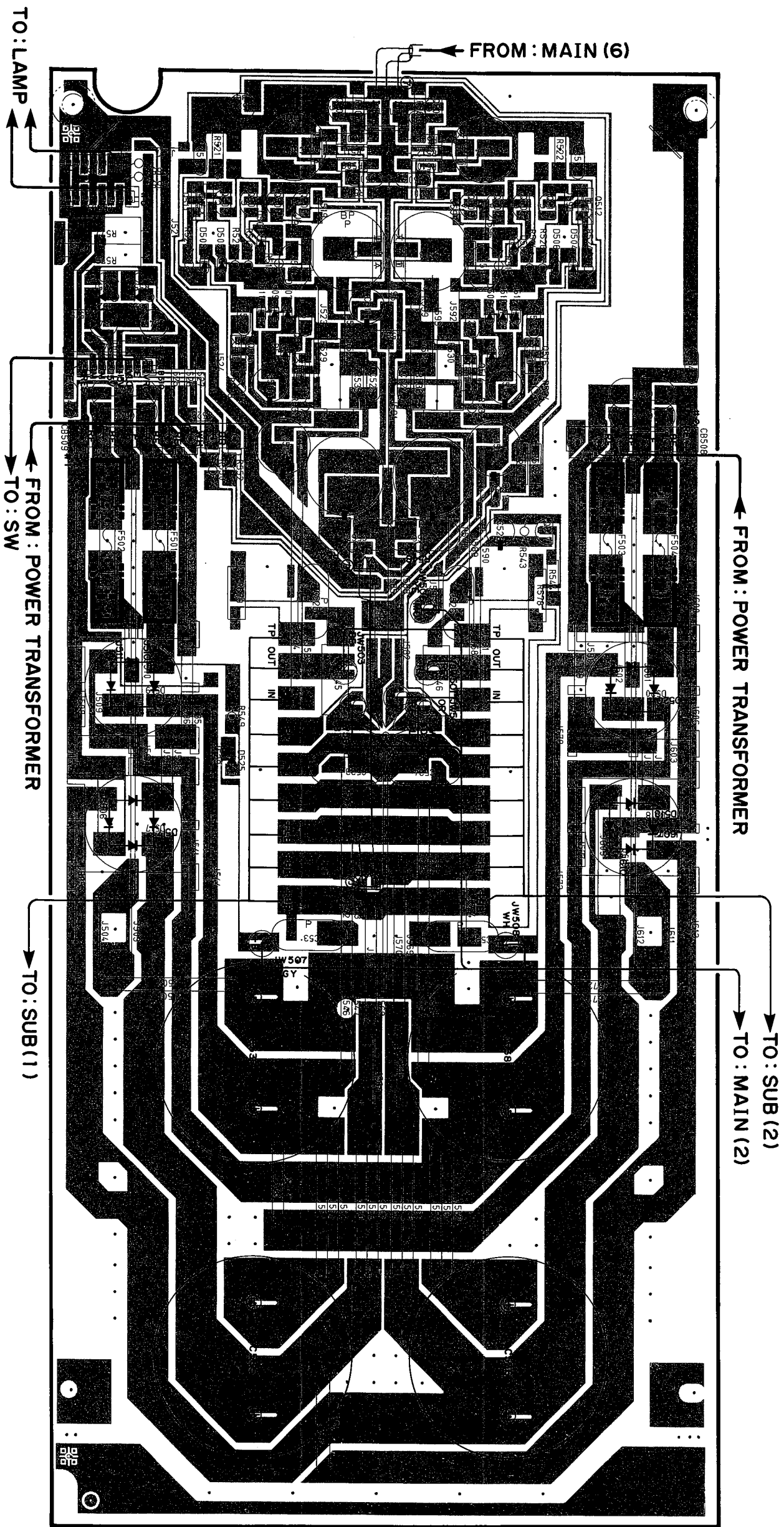

PRINTED CIRCUIT BOARD (Pattern side)

Note) 文字面 : Component side

Note) * marked

U.C,R,A	B,G	
C563, 564	OPEN (P)	0.01/100
R573, 574	OPEN	2.2
C567 ~ 562	OPEN (P)	4700P/100

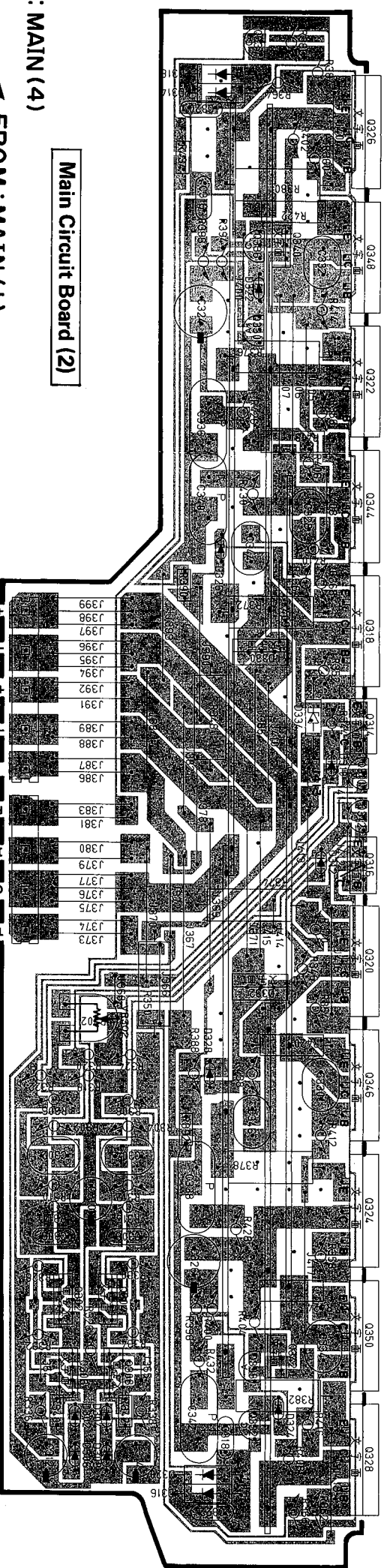

Sub Circuit Board (2)

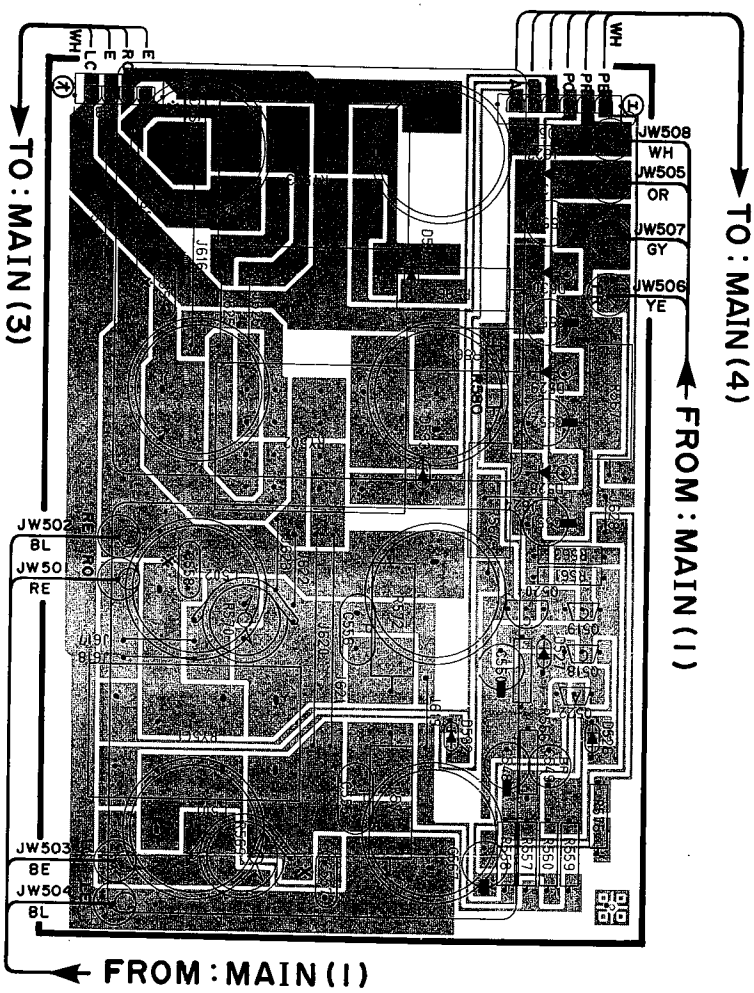

Main Circuit Board (2)

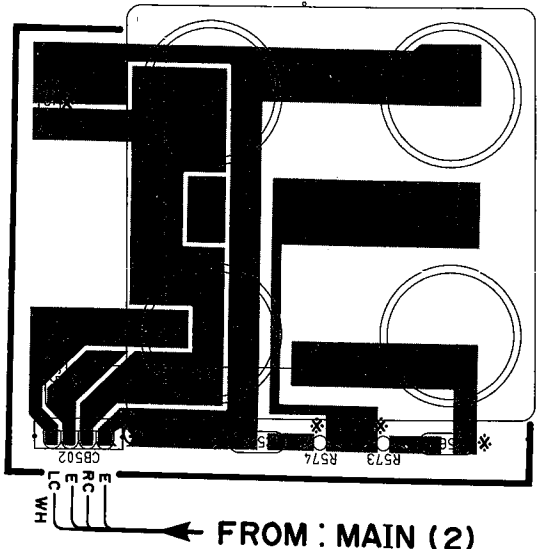

Main Circuit Board (3)

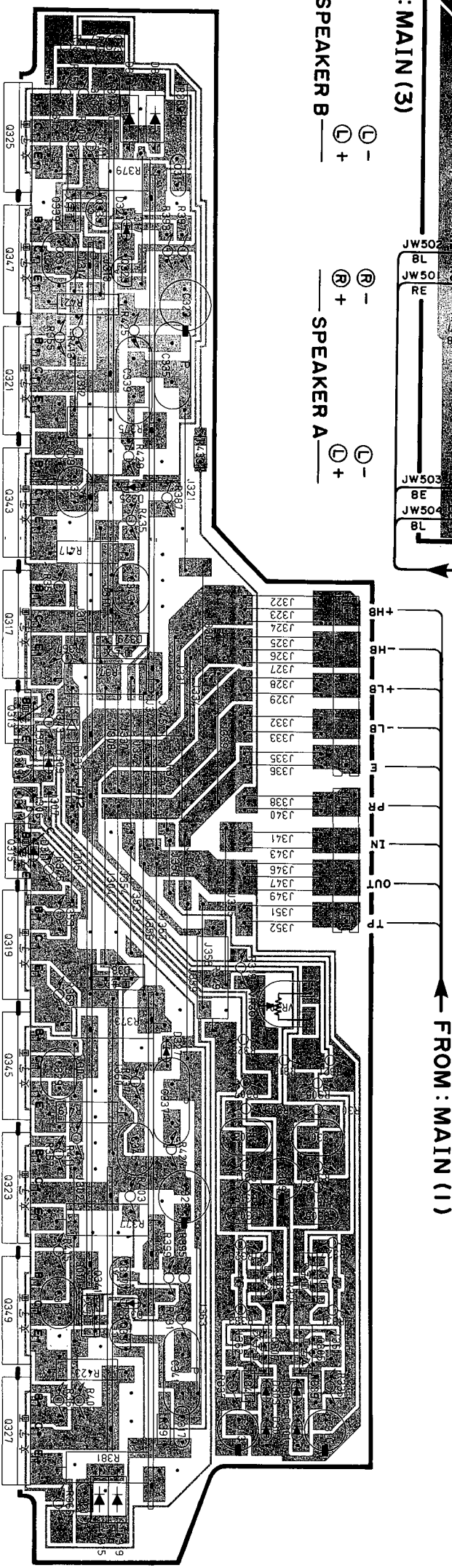

Sub Circuit Board (1)

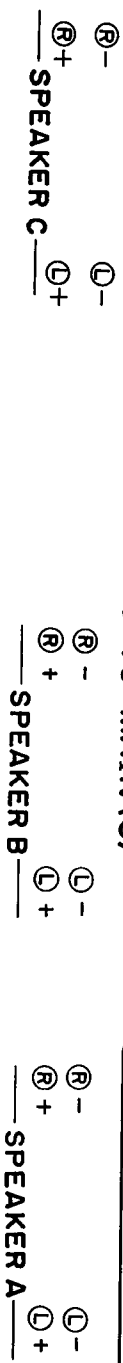

PRINTED CIRCUIT BOARD (Pattern side)

Note) 文字面 : Component side

Main Circuit Board (4)

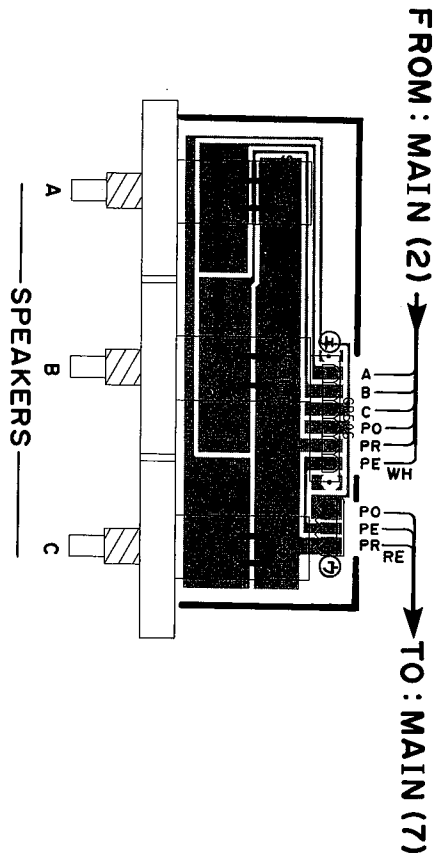

Switch Circuit Board

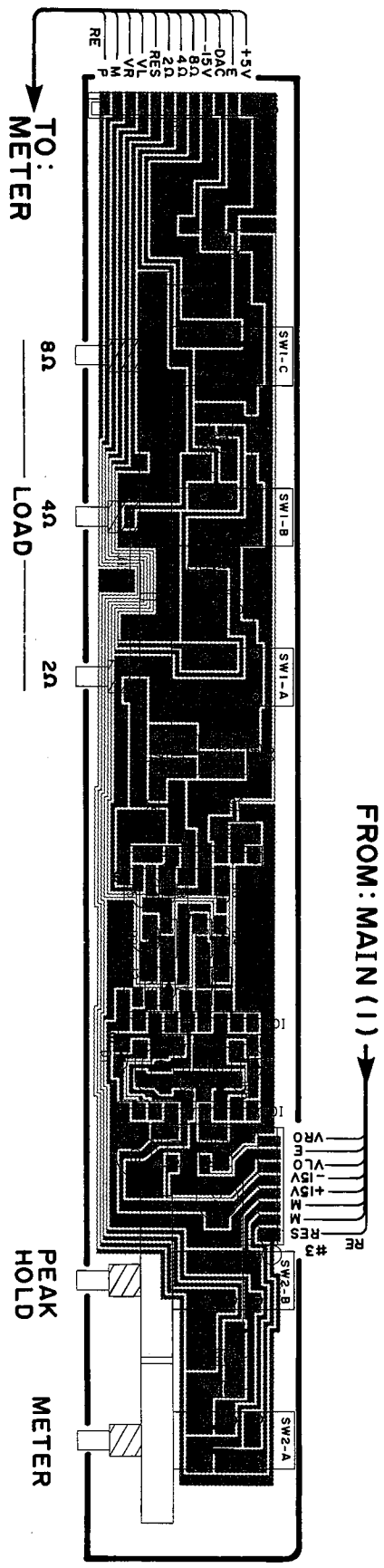

Main Circuit Board (7)



Main Circuit Board (5)

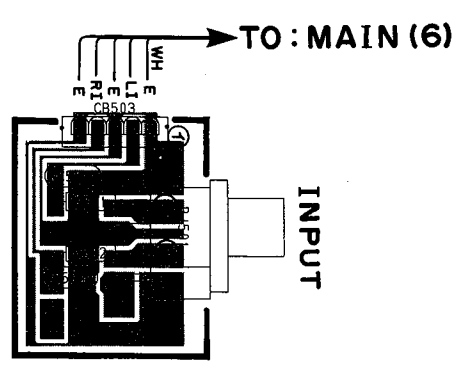

Meter Circuit Board

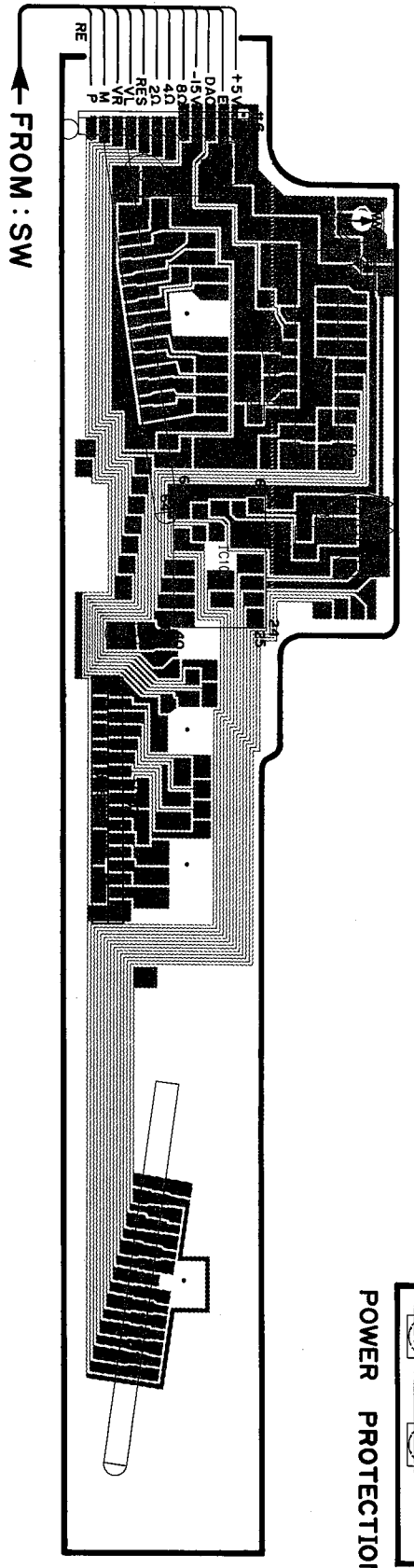

Main Circuit Board (6)

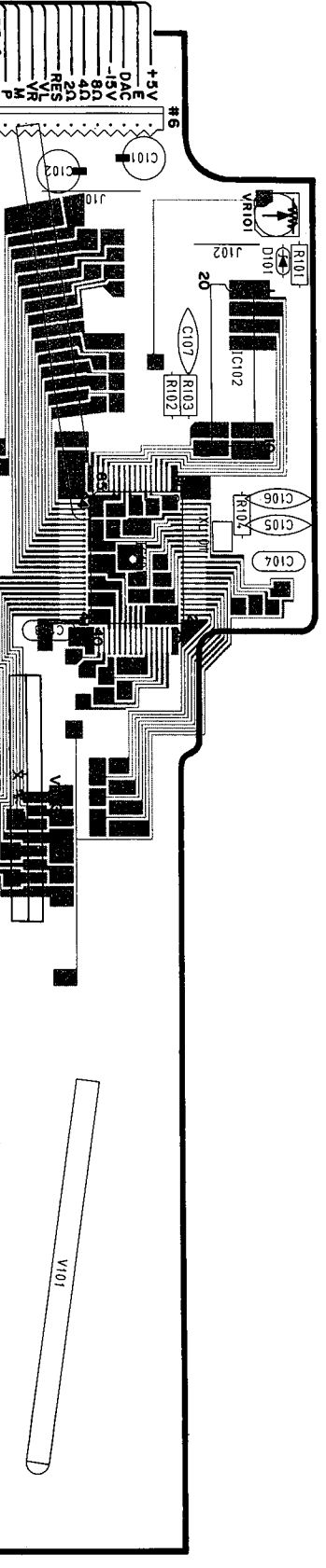
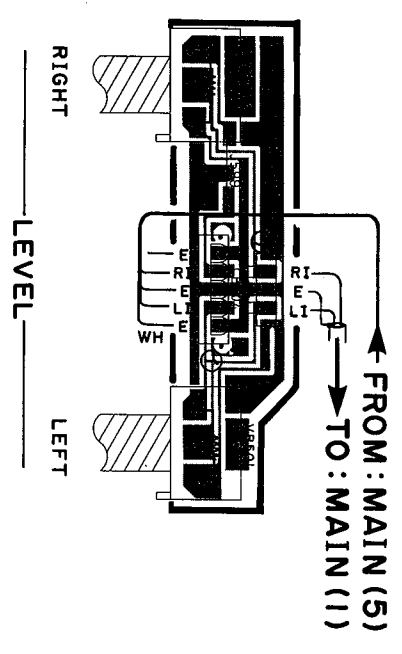

PRINTED CIRCUIT BOARD (Pattern side)

R MODEL

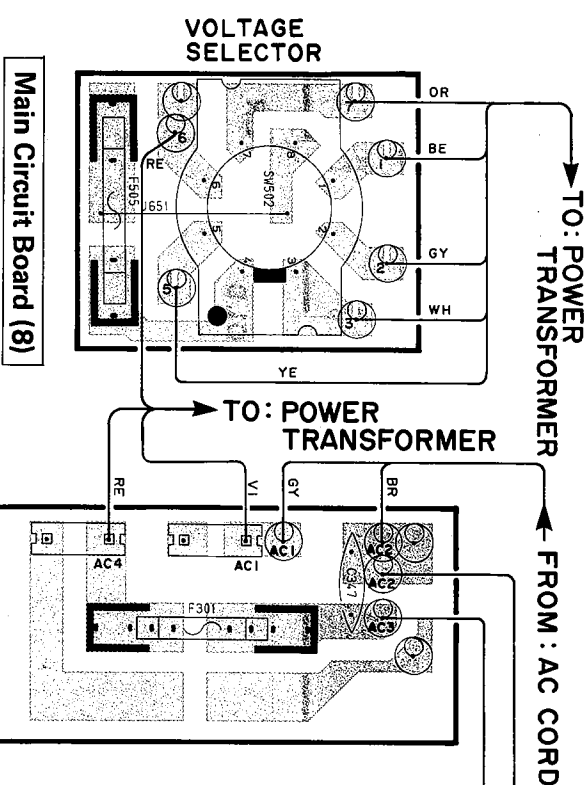

Main Circuit Board (8)

TO: POWER TRANSFORMER

FROM: AC CORD

R MODEL

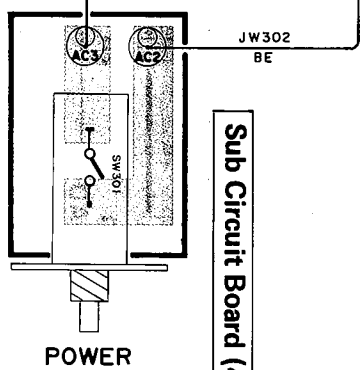

Sub Circuit Board (4)

POWER

A MODEL

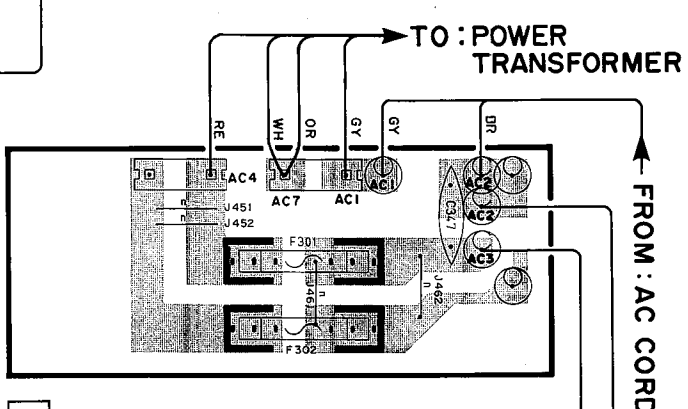

Main Circuit Board (3)

TO: POWER TRANSFORMER

FROM: AC CORD

Sub Circuit Board (4)

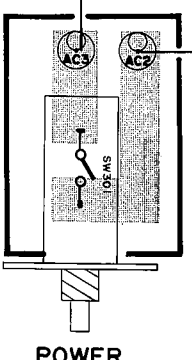

POWER

B, G MODELS

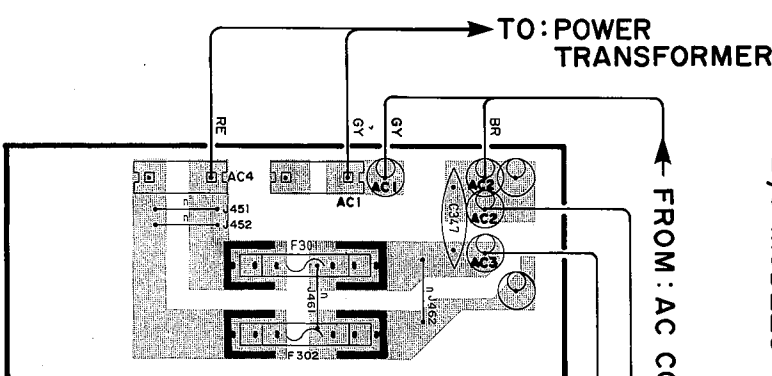

Main Circuit Board (3)

TO: POWER TRANSFORMER

FROM: AC CORD

Sub Circuit Board (4)

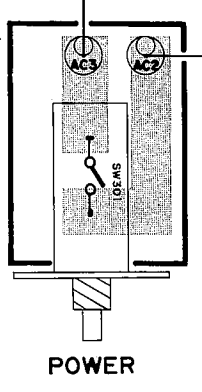

POWER

C MODEL

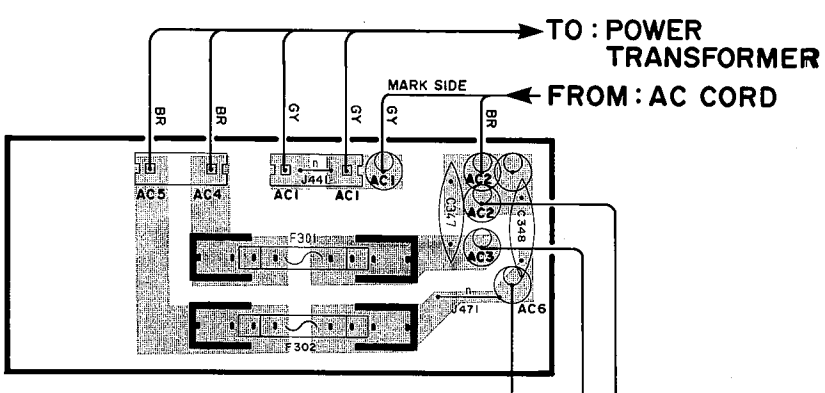

Main Circuit Board (3)

TO: POWER TRANSFORMER

FROM: AC CORD

Sub Circuit Board (4)

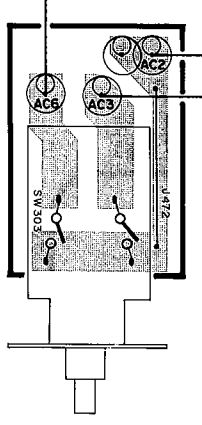

POWER

U MODEL

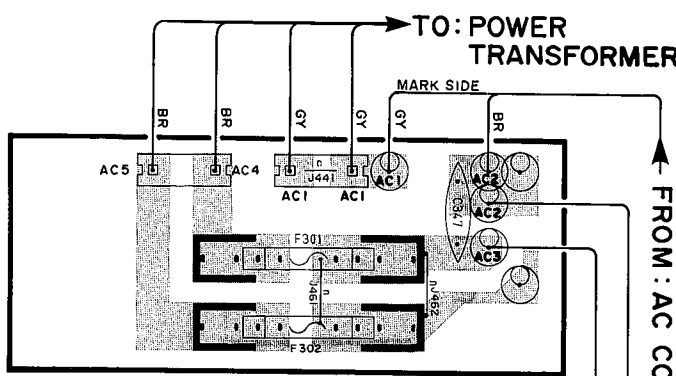

Main Circuit Board (3)

TO: POWER TRANSFORMER

FROM: AC CORD

Sub Circuit Board (4)

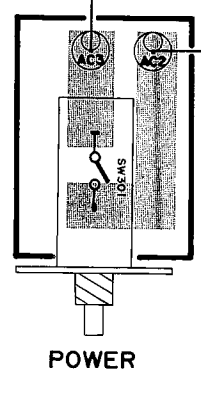

POWER

VOLTAGE SELECTOR

220V ← 240V

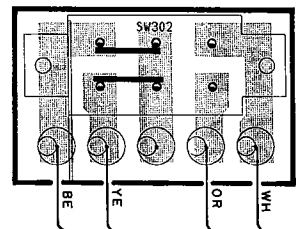

Sub Circuit Board (5)

TO: POWER TRANSFORMER

■ WIRING

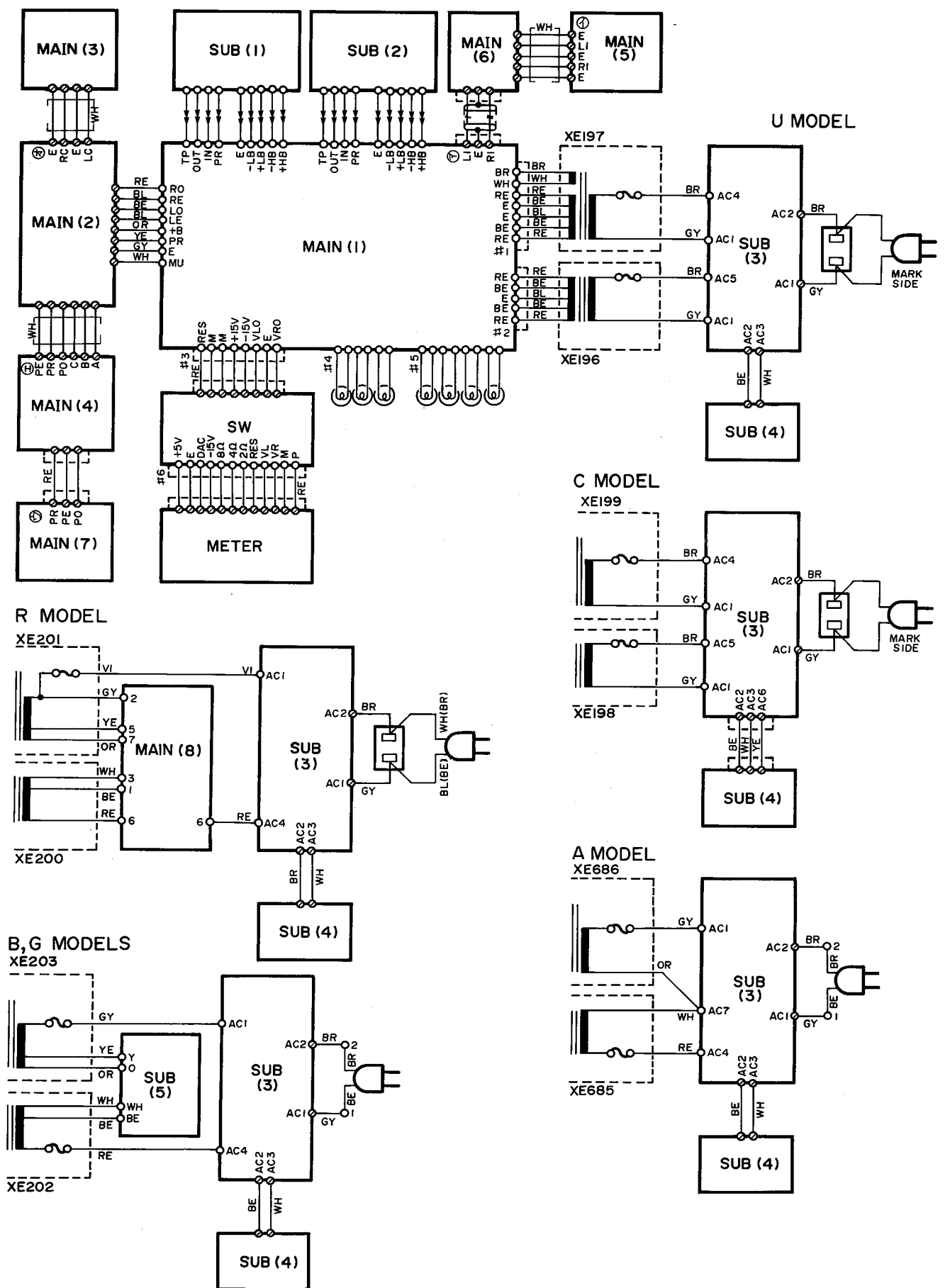

U/1000-U

PARTS LIST

■WARNING

Components having special characteristics are marked \triangle and must be replaced with parts having specifications equal to those originally installed.

● Carbon resistors (1/6W or 1/4W) are not included in the ELECTRICAL PARTS list. For the parts No. of the carbon resistor, refer to p. 24.

■ ELECTRICAL PARTS

Ref. No.	Part No.	Description	部 品 名	Remarks	Common Model	Markets	ランク
※	NA 09 76 60	Main Circuit Board	メ イ ン シ ー ト			U,C	
※	NA 09 96 00	〃	〃			R	
※	NA 09 76 70	〃	〃			A	
※	NA 09 76 80	〃	〃			B,G	
	FU 35 05 00	Mica Cap.	マ イ カ コ ン	5pF 500V	C523,524		
	FU 35 16 80	〃	〃	68pF 500V	C519~522		
	FU 35 22 20	〃	〃	220pF 500V	C501,502,505,506,513,514		
※	VE 87 59 00	Polypropylene Film cap.	ポ リ プ ロ コ ン	0.022 μ F 100V	C555,556		
※	VE 87 45 00	〃	〃	0.047 μ F 100V	C525,526,531~534,565,566		
※	VF 47 40 00	〃	〃	3300pF 100V	C509,510		
	UT 45 34 70	〃	〃	4700pF 100V	C557~562	B,G	
	UT 45 41 00	〃	〃	0.01 μ F 100V	C563,564	B,G	
	FA 15 51 00	Mylar Cap.	マ イ ラ ー コ ン	0.1 μ F 50V	C544,545		
	FZ 00 06 70	Metallized Cap.	M M コ ン	0.047 μ F 400V	C540~543		
	UJ 11 82 20	Electrolytic Cap.	ケ ミ コ ン	220 μ F 6.3V	C550		
	UJ 13 83 30	〃	〃	330 μ F 16V	C546,547		
	UJ 14 71 00	〃	〃	10 μ F 25V	C548		
	UJ 16 71 00	〃	〃	10 μ F 50V	C528		
	UJ 16 81 00	〃	〃	100 μ F 50V	C551~553		
	FM 11 62 20	〃	B P コ ン	2.2 μ F 50V	C527		
	UK 16 64 70	〃	〃	4.7 μ F 50V	C549		
	FZ 00 54 10	〃	ブ ラ ッ ク ゲ ー ト コ ン	100 μ F 6.3V	C517,518		
	UW 67 74 70	〃	オ ー デ ィ オ ケ ミ コ ン	47 μ F 63V	C515,516		
	VE 80 27 00	〃	B P コ ン	33 μ F 50V	C503,504		
	VF 47 28 00	〃	〃	47 μ F 50V	C507,508		
※	VE 94 16 00	〃	オ ー デ ィ オ ケ ミ コ ン	820 μ F 110V	C529,530		
※	VE 02 20 00	〃	ケ ミ コ ン D U O R E X	10 μ F 100V	C511		
	VC 79 37 00	Coil	コ イ ル	1.5 μ H	L501,502		
	HU 57 54 70	Metal Film Resistor	金 属 皮 膜 抵 抗	470 Ω 1/4W	R501,502,505,506		
	HU 59 61 00	〃	〃	1k Ω 1/4W	R511,512		
	HU 57 72 70	〃	〃	27k Ω 1/4W	R509,510,535,536		
※	VF 63 53 00	Carbon Resistor	カ ー ボ ン 抵 抗	68 Ω 1/4W	R517,518		
	HJ 35 61 00	〃	〃	1k Ω 1/4W	R507,508		
	HJ 35 64 70	〃	〃	4.7k Ω 1/4W	R575		
	HJ 35 71 00	〃	〃	10k Ω 1/4W	R580		
	HJ 35 73 30	〃	〃	33k Ω 1/4W	R544		
	HJ 35 74 70	〃	〃	47k Ω 1/4W	R521,522,541,542,563		
	HJ 35 76 80	〃	〃	68k Ω 1/4W	R519,520		
	HJ 35 81 00	〃	〃	100k Ω 1/4W	R540,568		
	HJ 35 82 20	〃	〃	220k Ω 1/4W	R556,559,560		
	HJ 35 84 70	〃	〃	470k Ω 1/4W	R557,558		
	HJ 35 88 20	〃	〃	820k Ω 1/4W	R561		
	HL 31 61 00	Metal Oxide Film Resistor	酸 金 抵 抗	1k Ω 1W	R578,579		
	HL 32 32 20	〃	〃	2.2 Ω 2W	R571,572		
	HL 32 34 70	〃	〃	4.7 Ω 2W	R545,546,576,577		
	HL 32 53 30	〃	〃	330 Ω 2W	R564~566		
	HL 32 63 90	〃	〃	3.9k Ω 2W	R567		
	HL 32 71 00	〃	〃	10k Ω 2W	R527~530		
	HV 45 31 00	Flame Proof Carbon Resistor	不 燃 化 カ ー ボ ン 抵 抗	1 Ω 1/4W	R547~549,554,555		
	HV 45 32 20	〃	〃	2.2 Ω 1/4W	R573,574	B,G	
	HV 45 34 70	〃	〃	4.7 Ω 1/4W	R551,553		

※New Parts (新規部品) NR

Ref. No.	Part No.	Description	部 品 名	Remarks	Common Model	Markets	ランク
	HV 45 41 00	Flame Proof Carbon Resistor	10Ω 1/4W	不燃化カーボン抵抗	R569,570		
	HV 45 42 20	//	22Ω 1/4W	//	R525,526		
	HV 45 51 00	//	100Ω 1/4W	//	R531~534		
	HV 45 52 20	//	220Ω 1/4W	//	R513~516,550,552		
	HV 45 58 20	//	820Ω 1/4W	//	R523,524		
	HV 45 66 80	//	6.8kΩ 1/4W	//	R543		
	HV 45 71 00	//	10kΩ 1/4W	//	R539		
※	VE 64 25 00	Potentiometer	B60kΩ	可 変 抵 抗 器	VR501,502		
	iA 09 70 00	Transistor	2SA970(GR,BL)	ト ラ ン ジ ス タ ー	Q503~506,517		
	iA 11 15 10	//	2SA1115(E,F)	//	Q521,522	} Inter-changeable	
	iX 60 31 70	//	2SA1310(R,S,T)	//	//		
	iA 13 52 00	//	2SA1352	//	Q515,516		
	iC 05 35 40	//	2SC535(A,B,C)	//	Q501,502		
	iC 18 15 20	//	2SC1815(Y)	//	Q509,510		
	iC 22 40 00	//	2SC2240(GR,BL)	//	Q507,508		
	iC 26 03 10	//	2SC2603(E,F)	//	Q518,519	} Inter-changeable	
	iX 60 31 80	//	2SC3312(R,S,T)	//	//		
	iC 34 16 00	//	2SC3416	//	Q511~514		
	iD 04 00 30	//	2SD400	//	Q520		
	iF 00 34 50	Diode	ISS133	ダ イ オ ー ド	D501~512,526,527		
	VC 39 84 00	//	MA185	//	D513,514		
	iH 00 14 30	//	ISR35-100A	//	D521,522,525,528~531		
	iF 01 07 50	Zener Diode	MTZ6.2C	ツェナーダイオード	D515		
	iF 00 90 90	//	MTZ24C	//	D532~534		
	iF 00 44 40	LED(Red)	SLV-56URC3H	L E D	D535,536		
	iH 00 11 30	Diode Bridge	D5FB20	ダイオードブリッジ	D517~520		
	KA 80 46 60	Push Switch		プッシュスイッチ	SW501		
	VA 96 18 00	Voltage Selector		電 圧 切 替 器	SW502	R	△
	KC 00 14 10	Relay	JC2aD DC24V	リ レ ー	RY501		
	KC 00 19 20	//	MS4U	//	RY502,503		
※	VE 64 24 00	Pin Jack	2P	ピ ン ジ ャ ッ ク	PJ501		
	KB 00 14 90	Fuse	10A 250V	ヒ ユ ー ズ	F505	R	△
	KB 00 17 60	//	T6.3A 250V	//	F501~504	A,B,G	△
	KB 00 15 20	//	7A 125V	//	F501~504	U,C,R	△
	VA 72 54 00	Holder	4P	パ ラ レ ル ホ ル ダ ー	CB501,502		
	VA 72 55 00	//	5P	//	CB503,504		
	VA 72 56 00	//	6P	//	CB505,506		
	VD 00 49 00	Base Pin	6P	P H ベ ー ス ピ ン	CB511		
	VD 00 51 00	//	8P	//	CB507,510		
※	LB 60 50 60	//	8P	S V ベ ー ス ピ ン	CB509		
※	LB 60 50 70	//	6P	//	CB508		
※	VE 79 57 00	Speaker Terminal	4P	S P タ ー ミ ナ ル		B,G	
※	VE 79 61 00	//	4P	//		U,C,R,A	
※	VE 79 58 00	//	4P	//		B,G	

※New Parts (新規部品) NR

MX-1000/U

Ref. No.	Part No.	Description	部 品 名		Remarks	Common Model	Markets	ランク
※	VE 79 63 00	Speaker Terminal	4P	S P ターミナル			U,C,R,A	
	LB 20 10 60	Fuse Holder Pin	YSH403T	ヒューズホルダーピン			A,B,G	
	LB 20 19 70	//	2316508I	//			U,C,R	
	BB 07 07 00	Ground Plate		アース金具				
	BB 07 04 10	Bus Bar	ℓ = 55	バスバー				
	BB 07 04 20	//	ℓ = 100	//				
	BB 06 62 90	Washer		アースワッシャー				
※	NA 09 77 80	Meter Circuit Board		メーターシート				
	FG 21 22 20	Ceramic Cap.	220pF 50V	セラコン	C105,106			
	FG 24 41 00	//	0.01μF 50V	//	C107			
	FA 15 51 00	Mylar Cap.	0.1μF 50V	マイラーコン	C103,104			
	UJ 13 71 00	Electrolytic Cap.	10μF 16V	ケミコン	C101,102			
	GG 00 07 60	Ceramic Resonator	CSB800K	セラミック振動子	XL101			
	VB 86 12 00	Pre-Set Potentiometer	B2.2kΩ	半固定抵抗	VR101			
	iF 00 88 10	Zener Diode	MTZ3.6B	ツェナーダイオード	DI01			
※	iG 10 60 00	IC	BA922I	I C	IC102			
※	XD 98 40 01	//	LC5812H	//	IC101			
※	VE 82 71 00	LCD Unit		L C D 表示器	VI01,102			
※	VE 82 70 00	//		//	VI03			
	VE 77 46 00	Reflector		リフレクター				
	VE 77 47 00	//		//				
	CB 06 88 80	Plastic Rivet		プラスチックリベット				
	VE 77 51 00	Sheet,B		シート B				
	VE 77 53 00	// ,D		// D				
※	NA 09 78 00	Switch Circuit Board		スイッチシート				
	UJ 13 71 00	Electrolytic Cap.	10μF 16V	ケミコン	C1~4			
	UJ 16 51 00	//	0.1μF 50V	//	C5			
	iC 22 40 00	Transistor	2SC2240(GR,BL)	トランジスター	Q1			
	iF 00 34 50	Diode	ISS133	ダイオード	DI~8,10			
	iF 01 06 90	Zener Diode	MTZ5.1B	ツェナーダイオード	D9			
	XA 42 60 01	IC	NJM5532S	I C	IC1			
	iG 07 68 00	//	NJM4558S	//	IC3			
	XB 24 70 01	//	μPC4570HA	//	IC2			
※	VE 64 22 00	Push Switch	2-2	プッシュスイッチ	SW2			
※	VE 64 23 00	//	2-2	//	SW1			
※	LB 94 51 20	Short Plug	I2P i-Type	i型ショートプラグ	CB1			

※New Parts (新規部品) NR

Ref. No.	Part No.	Description	部品名	Remarks	Common Model	Markets	ラング
※	MA 09:76:90	Sub Circuit Board	サブボード			U	
※	MA 09:77:00	"	"			C	
※	MA 09:77:10	"	"			R	
※	MA 09:77:20	"	"			A	
※	MA 09:77:30	"	"			B,G	
※	FI 51:41:00	Ceramic Cap.	セラミック	C347		C	
※	FI 51:41:00	"	"	C348		C	
※	UJ 16:81:00	Electrolytic Cap.	カーボン電解コン	C323~326			
※	FZ 00:64:10	"	セラミックコン	C311~314			
※	FZ 00:64:10	"	セラミックコン	C309,310			
※	VF 47:40:00	Polypropylene Film Cap.	ポリプロピレン	C301~304			
※	UT 45:21:00	"	"	C319~322			
※	UT 45:21:50	"	"	C315~318			
※	UT 45:22:20	"	"	C305~308			
※	VF 27:98:00	"	"	C327~330			
※	VE 87:59:00	"	"	C331~334,343~346			
※	VE 87:45:00	"	"	C335~342			
※	HL 32:68:20	Metal Oxide Film Resistor	酸化金属抵抗	R347~350			
※	VE 86:93:00	"	"	R417~424			
※	HL 93:22:20	"	"	R371~382			
※	HV 45:32:20	Flame Proof Carbon Resistor	不燃化カーボン抵抗	R351~362,409~416			
※	HV 45:34:70	"	"	R425~432,435~438			
※	HV 45:42:20	"	"	R343~346			
※	HV 45:44:70	"	"	R405~408			
※	HV 45:46:80	"	"	R367~370			
※	HV 45:51:00	"	"	R301~304			
※	HV 45:52:20	"	"	R363~366			
※	HV 45:61:00	"	"	R309~316,325~334,401~404			
※	HV 45:62:70	"	"	R305~308			
※	HV 45:63:30	"	"	R385,386			
※	HV 45:64:70	"	"	R393~400			
※	HV 45:71:00	"	"	R383,384			
※	HV 45:71:50	"	"	R321~324,335~338			
※	HV 45:72:20	"	"	R317~320			
※	HT 37:03:90	Pre-Set Potentiometer	半固定抵抗	R387,388			
※	IA 09:70:00	Transistor	トランジスタ	VR301,302			
※	IA 11:45:00	"	"	Q309,310			
※	IC 22:40:00	"	"	Q329,330,337,338			
※	IC 27:05:00	"	"	Q311,312,333,334			
※	IA 13:49:00	Dual Transistor	デュアルトランジスタ	Q331,332,335,336			
※	IC 33:81:00	"	"	Q301,302,307,308			
※	IC 32:98:50	Pair Transistor	ペアトランジスタ	Q303~306			
※	IX 60:35:80	"	"	Q315,316			
※	IX 60:35:90	"	"	Q313,314			
※	IX 60:81:10	"	"	Q341,342			
※	IX 60:81:20	"	"	Q339,340			
※	IX 61:21:20	"	"	Q319,320,323,324,327,328			
※	IX 61:21:30	"	"	Q317,318,321,322,325,326			
※	IX 61:21:30	"	"	Q345,346,349,350			
※	IX 61:21:30	"	"	Q343,344,347,348			

※New Parts (新規部品) NR

Ref. No.	Part No.	Description	部品名	Remarks	Common Model	Markets	ラング
※	VC:39:84:00	Diode	ダイオード	MA185		D309~312	
※	IF:00:34:50	"	"	ISS133		D301~308	
※	IH:00:02:40	"	"	IS1885		D313~320	
※	VE:86:95:00	"	"	SKF108		D329~332	
※	IF:00:88:60	Zener Diode	ツェナーダイオード	MTZ12B		D321~324	
※	IF:00:90:90	"	"	MTZ24C		D325~328	
※	VF:60:06:00	"	"	RD4,3FB		D333,334	
※	KA:80:43:00	Push Switch	押しスイッチ	TV-8		SW302	
※	VE:73:47:00	"	"	TV-8 SDDF		SW303	
※	VE:96:26:00	Slide Switch	スライドスイッチ	TV-8 SDDF		SW301	
※	VD:37:09:00	Fuse	ヒューズ	10A		F301,302	
※	KB:00:07:90	"	"	T4A		F301,302	
※	VE:87:63:00	"	"	20A		F301	
※	LB:20:10:60	Fuse Holder Pin	ヒューズホルダーピン	YSH403T		A,B,G	
※	LB:20:19:70	"	"	2316581		U,C,R	
※	LA:00:25:80	Lapping Terminal	P=10 2P I-Type				
※	LA:00:23:30	"	"	P=7.5 4P I-Type			
※	LA:00:23:40	"	"	P=7.5 5P I-Type			
※	BB:07:04:10	Bus Bar	バスバー	ℓ=55			
※	BB:07:04:20	"	"	ℓ=100			
※	BB:07:04:30	"	"	ℓ=150			

※New Parts (新規部品) NR

EXPLODED VIEW

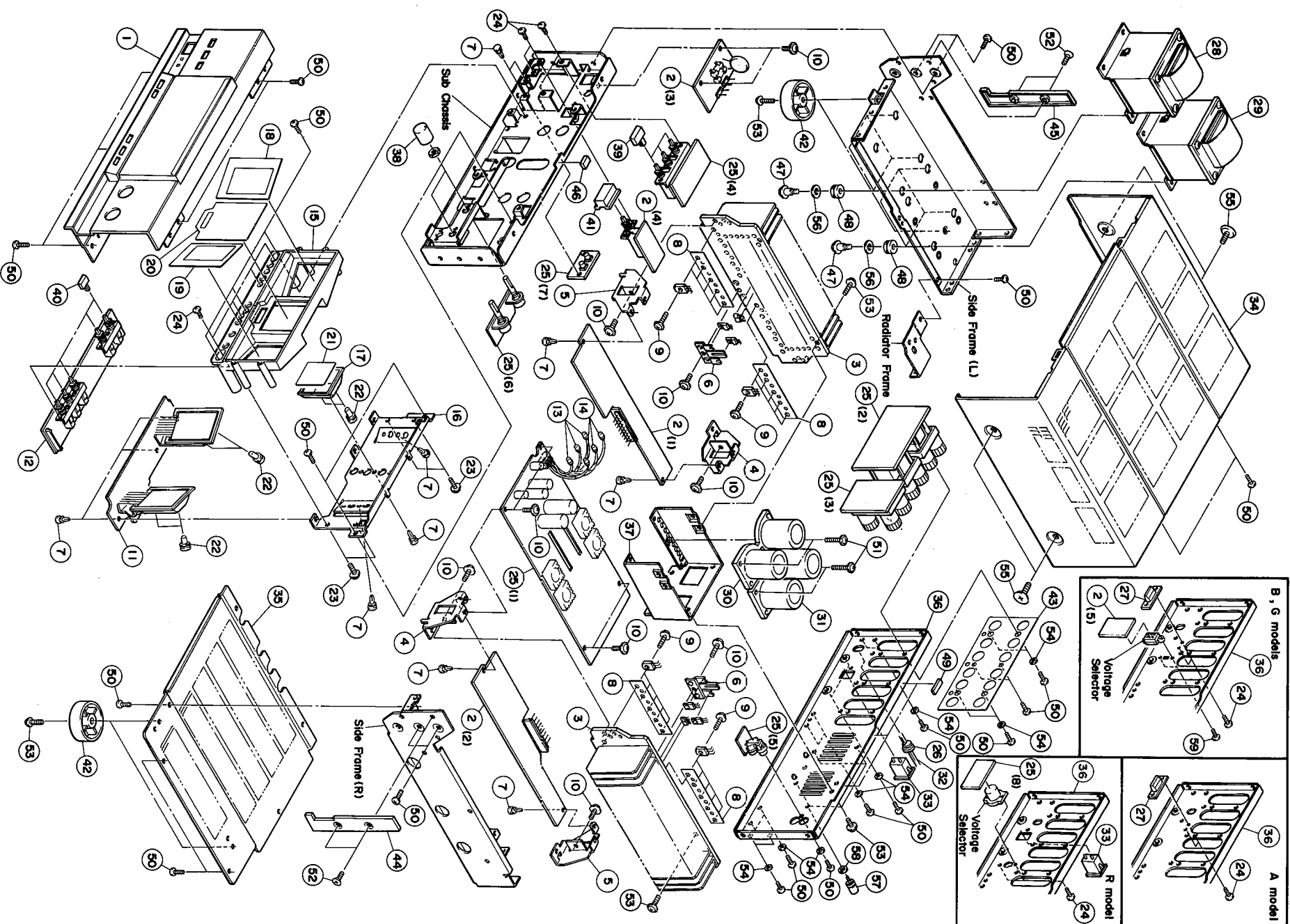

MECHANISM PARTS

Note) φ: Diameter

Ref. No.	Part No.	Description	部 品 名	Remarks	Common Model	Markets	ラック
1	VE 92 08 00	Panel Unit	パネルユニット	MX-1000U		U,C	
2	NA 09 16 90	Sub Circuit Board	サブシートの	MX-1000		R,A,B,G	
3	VE 77 22 00	Radiator	ラジエター			B,G	
4	VE 77 53 00	Radiator Frame(L)	ラジエターフレーム(L)			A	
5	VE 77 64 00	Transistor Frame	トランジスタフレーム			R	
6	VE 77 65 00	Plastic Rivet	プラスチックリベット			A	
7	VE 77 66 00	Sheet	板			B,G	
8	EZ 00 13 50	Cup Screw	カップネジ				
9	EX 60 02 40	BW Head Tapping Screw	BWヘッドタッピングネジ				
10	NA 09 77 80	Meter Circuit Board	メーターシートの				
11	NA 09 78 00	Switch Circuit Board	スイッチシートの				
12	VF 51 82 00	Pilot Lamp	パイロットランプ				
13	VF 51 83 00	Meter Sub Panel	メーターサブパネル				
14	VE 77 20 00	Meter Frame	メーターフレーム				
15	VE 77 45 00	Display Reflector	ディスプレイリフレクター				
16	VE 77 58 00	Plate, (L)	プレート(L)				
17	VE 77 59 00	Plate, (R)	プレート(R)				
18	VE 77 60 00	Plate, (D)	プレート(D)				
19	VE 77 52 00	Lamp Cap.	ランプキャップ				
20	VE 92 91 00	BW Head Tapping Screw	BWヘッドタッピングネジ				
21	ED 33 00 30	Binding Head Screw	バインディングヘッドネジ				
22	NA 09 76 60	Main Circuit Board	メインシートの	PACK		U,C	
23	NA 09 76 70	Terminal Plate	端子台			A	
24	NA 09 76 80	Power Transformer	電源トランス			B,G	
25	NA 09 96 00	Cord Stopper	コードストッパー			R,A	
26	CB 62 01 90	SR-4N-4	SR-4N-4			B,G	
27	CB 80 68 50	SR-6N3-4	SR-6N3-4			U,C	
28	VE 19 60 01	Power Transformer	電源トランス			A,B,G	
29	XE 19 80 01	Terminal Plate	端子台			U	
30	XE 20 00 01	Terminal Plate	端子台			C	
31	XE 20 01 01	Terminal Plate	端子台			R	
32	XE 20 10 01	Terminal Plate	端子台			B,G	
33	XE 20 30 01	Terminal Plate	端子台			A	
34	XE 20 30 01	Terminal Plate	端子台			U	
35	XE 20 30 01	Terminal Plate	端子台			C	
36	XE 20 30 01	Terminal Plate	端子台			R	
37	XE 20 30 01	Terminal Plate	端子台			B,G	
38	XE 20 30 01	Terminal Plate	端子台			A	
39	XE 20 30 01	Terminal Plate	端子台			U	
40	XE 20 30 01	Terminal Plate	端子台			C	
41	XE 20 30 01	Terminal Plate	端子台			R	
42	XE 20 30 01	Terminal Plate	端子台			B,G	
43	XE 20 30 01	Terminal Plate	端子台			A	
44	XE 20 30 01	Terminal Plate	端子台			U	
45	XE 20 30 01	Terminal Plate	端子台			C	
46	XE 20 30 01	Terminal Plate	端子台			R	
47	XE 20 30 01	Terminal Plate	端子台			B,G	
48	XE 20 30 01	Terminal Plate	端子台			A	
49	XE 20 30 01	Terminal Plate	端子台			U	
50	VE 90 54 00	Electrolytic Cap. Set	ケミコンセット	C537, 538 Pair		U,C	
51	VE 90 55 00	Electrolytic Cap. Set	ケミコンセット	C535, 536 Pair		R	
52	VE 01 31 00	Power Cord	電源コード			A	
53	MG 00 16 30	Power Cord	電源コード			B,G	
54	MG 00 23 10	Power Cord	電源コード				
55	MG 00 09 10	Power Cord	電源コード				

※New Parts (新規部品) NR

Ref. No.	Part No.	Description	部 品 名	Remarks	Common Model	Markets	ランク
33	LB 20 30 60	AC Outlet	A C アウトレット			U,C,R	△
34	AA 62 19 80	Top Cover	ト ッ プ カ バ ー		M-80		
35	AA 62 20 30	Bottom Cover	ボ ト ム カ バ ー		M-80		
※	36	VE 77 24 00	Rear Panel	リ ャ パ ネ ル	MX-1000	R	
※	//	VE 77 25 00	//	//	MX-1000U	U,C	
※	//	VE 77 26 00	//	//	MX-1000	A	
※	//	VE 77 27 00	//	//	MX-1000	B,G	
	37	AA 62 33 50	Holder, Capacitor	ケ ミ コ ン 金 具			
	38	BA 08 58 70	Knob	ツ マ ミ	LEVEL	A-05	
	39	VE 77 40 00	Button	ボ タ ン	SPEAKERS		
	40	CB 66 07 90	//	//	METER, LOAD	AX-900	
	41	VE 18 99 00	//	//	POWER	//	
	42	CB 66 09 50	Leg	レ ッ グ		//	
※	43	VE 79 35 00	Speaker Sheet	S P シ ー ト			
※	44	VE 77 36 00	Side Cover (R)	サイ ド カ バ ー (R)			
※	45	VE 77 37 00	// (L)	// (L)			
	46	CB 60 13 40	Spacer	ス ペ ー サ ー		T-6	
	47	AA 60 38 50	Special Screw	ダ ン ツ キ ネ ジ		A-6	
	48	CB 09 99 10	Rubber Cushion	防 振 ゴ ム		//	
	49	VD 60 83 00	Dumper Top	ダ ン パ ー ト ッ プ		CDX-1100	
	50	Ei 33 00 86	Binding Head Tapping Screw	3×8 FCRM3-BI	バ イ ン ド タ ッ ピ ン グ ネ ジ	PACK	
	51	EK 33 00 40	BW Head Tapping Screw	3×24(φ8)FCRM3-BI	B W ヘ ッ ド タ ッ ピ ン グ ネ ジ		
	52	EB 34 01 00	Flat Head Screw	4×10 FCRM3-BI	皿 小 ネ ジ		
	53	EK 33 60 10	BW Head Tapping Screw	3×8(φ8) FCM3-BI	B W ヘ ッ ド タ ッ ピ ン グ ネ ジ		
	54	EV 41 30 36	Toothed Lock Washer	φ3 FCRM3-BI	内 歯 付 座 金	PACK	
	55	AX 60 01 50	Screw	4×8 FCRM3-BI	化 粧 ネ ジ		
	56	EV 22 06 00	Plain Washer	φ6×φ13×1.0 FCM3-BI	平 座 金		
	57	AA 62 73 10	Ground Terminal	3×13	G N D タ ー ミ ナ ル		
	58	EV 90 13 60	Plain Washer	φ3.6×φ10×0.8 FNM3-3g	平 座 金		
	59	EJ 32 60 86	Pan Head Tapping Screw	2.6×8 ZMCZ-BI	ナ ベ タ ッ ピ ン グ ネ ジ	PACK	B,G
		CB 06 92 51	Binding Tie	BK-1	イ ン シ ュ ロ ッ ク タイ	PACK	

MX-1000/U

※New Parts (新規部品) NR

Parts List for Carbon Resistor

Value	1/4W Type Part No.	1/6W Type Part No.	Value	1/4W Type Part No.	1/6W Type Part No.
1.0 Ω	HJ353100	HF853100	12KΩ	HJ357120	HF857120
1.8 "	HJ353180	※	15 "	HJ357150	HF857150
2.2 "	HJ353220	HF853220	18 "	HJ357180	HF857180
3.3 "	HJ353330	HF853330	22 "	HJ357220	HF857220
4.7 "	HJ353470	HF853470	27 "	HJ357270	HF857270
5.6 "	HJ353560	HF853560	33 "	HJ357330	HF857330
10 "	HJ354100	HF854100	39 "	HJ357390	HF857390
15 "	HJ354150	HF854150	47 "	HJ357470	HF857470
22 "	HJ354220	HF854220	56 "	HJ357560	HF857560
27 "	HJ354270	HF854270	68 "	HJ357680	HF857680
33 "	HJ354330	HF854330	82 "	HJ357820	HF857820
39 "	HJ354390	HF854390	91 "	HJ357910	HF857910
47 "	HJ354470	HF854470	100 "	HJ358100	HF858100
56 "	HJ354560	HF854560	120 "	HJ358120	HF858120
68 "	HJ354680	HF854680	150 "	HJ358150	HF858150
82 "	HJ354820	HF854820	180 "	HJ358180	HF858180
100 "	HJ355100	HF855100	220 "	HJ358220	HF858220
110 "	HJ355110	HF855110	270 "	HJ358270	HF858270
120 "	HJ355120	HF855120	330 "	HJ358330	HF858330
150 "	HJ355150	HF855150	390 "	HJ358390	HF858390
160 "	HJ355160	※	470 "	HJ358470	HF858470
180 "	HJ355180	HF855180	560 "	HJ358560	HF858560
220 "	HJ355220	HF855220	680 "	HJ358680	HF858680
270 "	HJ355270	HF855270	820 "	HJ358820	HF858820
330 "	HJ355330	HF855330	1.0MΩ	HJ359100	HF859100
390 "	HJ355390	HF855390	1.2 "	HJ359120	※
470 "	HJ355470	HF855470	1.5 "	HJ359150	HF859150
510 "	※	HF855510	1.8 "	HJ359180	HF859180
560 "	HJ355560	HF855560	2.2 "	HJ359220	HF859220
680 "	HJ355680	HF855680	3.3 "	HJ359330	HF859330
820 "	HJ355820	HF855820	3.9 "	HJ359390	※
910 "	HJ355910	HF855910	4.7 "	HJ359470	HF859470
1.0KΩ	HJ356100	HF856100			
1.2 "	HJ356120	HF856120			
1.5 "	HJ356150	HF856150			
1.8 "	HJ356180	HF856180			
2.0 "	HJ356200	HF856200			
2.2 "	HJ356220	HF856220			
2.4 "	HJ356240	HF856240			
2.7 "	HJ356270	HF856270			
3.0 "	HJ356300	HF856300			
3.3 "	HJ356330	HF856330			
3.6 "	HJ356360	HF856360			
3.9 "	HJ356390	HF856390			
4.7 "	HJ356470	HF856470			
5.1 "	HJ356510	HF856510			
5.6 "	HJ356560	HF856560			
6.8 "	HJ356680	HF856680			
8.2 "	HJ356820	HF856820			
9.1 "	HJ356910	HF856910			
10 "	HJ357100	HF857100			

1/4W Type

HJ35○○○○

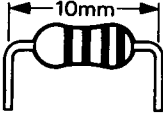

10mm

1/6W Type

HF85○○○○



5mm